



MIAMI-DADE COUNTY
 PRODUCT CONTROL SECTION
 11805 SW 26 Street, Room 208
 Miami, Florida 33175-2474
 T (786) 315-2590 F (786) 315-2599
www.miamidadecounty.gov/economy

DEPARTMENT OF REGULATORY AND ECONOMIC RESOURCES (RER)
 BOARD AND CODE ADMINISTRATION DIVISION
NOTICE OF ACCEPTANCE (NOA)

Quality Engineered Products Co., Inc.
 4506 Quality Lane
 Tampa, FL 33634

SCOPE:

This NOA is being issued under the applicable rules and regulations governing the use of construction materials. The documentation submitted has been reviewed and accepted by Miami-Dade County RER -Product Control Section to be used in Miami Dade County and other areas where allowed by the Authority Having Jurisdiction (AHJ).

This NOA shall not be valid after the expiration date stated below. The Miami-Dade County Product Control Section (In Miami Dade County) and/or the AHJ (in areas other than Miami Dade County) reserve the right to have this product or material tested for quality assurance purposes. If this product or material fails to perform in the accepted manner, the manufacturer will incur the expense of such testing and the AHJ may immediately revoke, modify, or suspend the use of such product or material within their jurisdiction. RER reserves the right to revoke this acceptance, if it is determined by Miami-Dade County Product Control Section that this product or material fails to meet the requirements of the applicable building code.

This product is approved as described herein and has been designed to comply with the Florida Building Code, including the High Velocity Hurricane Zone.

DESCRIPTION: Series "HMF" 16 ga or 14 ga Outswing Full Louvered Commercial Steel Door-Impact

APPROVAL DOCUMENT: Drawing No. **QEP005 Rev #2**, titled "Full Louvered Steel Doors", sheets 1 through 7 of 7, prepared by manufacturer, dated 01/31/18 and last revised on 03/03/21, signed and sealed by Cody Davis, P. E., bearing the Miami-Dade County Product Control Revision stamp with the Notice of Acceptance number and expiration date by the Miami-Dade County Product Control Section.

MISSILE IMPACT RATING: Large and Small Missile Impact Resistant

Limitations:

1. Not approved where Air & Water infiltration is needed.
2. Doors are 16 ga (min .063" thk) with min CS Tensile yield strength $F_y=46.3$ ksi and Tensile ultimate strength $F_u=52.1$ Ksi and SS Tensile yield strength $F_y=50.5$ ksi and Tensile ultimate strength $F_u=98.5$ Ksi

LABELING: Each unit shall bear a permanent label with the manufacturer's name or logo, city, state and series and following statement: "Miami-Dade County Product Control Approved", noted herein.

RENEWAL of this NOA shall be considered after a renewal application has been filed and there has been no change in the applicable building code negatively affecting the performance of this product.

TERMINATION of this NOA will occur after the expiration date or if there has been a revision or change in the materials, use, and/or manufacture of the product or process. Misuse of this NOA as an endorsement of any product, for sales, advertising or any other purposes shall automatically terminate this NOA. Failure to comply with any section of this NOA shall be cause for termination and removal of NOA.

ADVERTISEMENT: The NOA number preceded by the words Miami-Dade County, Florida, and followed by the expiration date may be displayed in advertising literature. If any portion of the NOA is displayed, then it shall be done in its entirety.

INSPECTION: A copy of this entire NOA shall be provided to the user by the manufacturer or its distributors and shall be available for inspection at the job site at the request of the Building Official.

This NOA revises NOA # 19-0731.04 and consists of this page 1 and evidence pages E-1, E-2 & E-3, as well as approval document mentioned above.

The submitted documentation was reviewed by **Ishaq I. Chanda, P.E.**



Ishaq I. Chanda

NOA No. 20-1123.20
 Expiration Date: October 28, 2024
 Approval Date: April 01, 2021
 Page 1

Quality Engineered Products Co, Inc.

NOTICE OF ACCEPTANCE: EVIDENCE SUBMITTED

1. Evidence previously submitted

A. DRAWINGS

1. Manufacturer's die drawings and sections (Submitted under files below)
2. Drawing No. QEP005, titled "Full Louvered Steel Door", sheets 1 through 7 of 7, prepared by manufacturer, dated 02/26/16, with Revision 1 dated 02/26/16, signed and sealed by Cody Davis, P. E.

B. TESTS (Submitted under files #15-0422.11/#14-1015.05/#09-0812.17/#04-0823.03)

1. Test reports on 1) Air Infiltration Test, per FBC TAS 202-94 (Not Performed)
 - 2) Uniform Static Air Pressure Test, Loading per FBC TAS 202.
 - 3) Water Resistance Test per FBC TAS 202-94 (Not Performed).
 - 4) Large Missile Impact Test per FBC, TAS 201-94
 - 5) Cyclic Wind Pressure Loading per FBC, TAS 203-94
 - 6) Forced Entry Test, per FBC and TAS 202-94

Along with marked-up drawings and installation diagram of double Outswing full louvered Commercial Steel Doors, prepared by Certified Testing Laboratories Inc., Test Report No. CTLA 1255-W-R, w/ revision dated September 14, 2004 (original test report dated July 28, 2004), signed and sealed by Ramesh Patel, P. E.)

Along with marked-up drawings and installation diagram of double Outswing Flush Steel Doors, prepared by Certified Testing Laboratories Inc., Test Report No. CTLA 1998W, dated 04/06/10, signed and sealed by Ramesh Patel, P. E.

C. CALCULATIONS

1. Anchor verification calculations, dated 05/17/16, prepared, signed and sealed Cody Davis, P.E.

D. QUALITY ASSURANCE

- 1 Miami Dade Department of Regulatory and Economic Resources (RER)

E. MATERIAL CERTIFICATIONS

1. Tensile test report prepared by Certified Testing Laboratories Inc., Test Report No. CTL 1023J (CTLA114W), tested per ASTM E-A370-97, dated December 02,2003, signed and sealed by Ramesh Patel, P. E. (Submitted under file # 09-0812.17)
2. Tensile test report prepared by Certified Testing Laboratories Inc., Test Report No. CTL 0638K (CTLA1255W), tested per ASTM E-A370-97, dated 09/13/04, signed and sealed by Ramesh Patel, P. E.
3. Notice of Acceptance No. 11-0926.07 issued to Dyplastic Products, LLC (former Apache Products Co) for "EPS-Expanded Polystyrene Insulation", expiring on 01/11/2017.

F. STATEMENTS

1. Statement letter of conformance, complying with FBC-2014, 5th edition and "No financial interest", issued, prepared, signed, sealed and dated 05/31/16 by Cody Davis, P. E.
2. Statement letter dated 05/31/16 of successor engineer adopting as his own, another engineer's work per FAC, Rule Chapter 61G15-27, issued by Master Consulting Engineers, Inc., both signed and sealed by Cody Davis, P. E.

G. OTHER

1. This revises & renews NOA # 14-1015.05, expiring October 28, 2019.

Ishaq I. Chanda

Ishaq I. Chanda, P.E.
Product Control Unit Supervisor
NOA No. 20-1123.20
Expiration Date: October 28, 2024
Approval Date: April 01, 2021

Quality Engineered Products Co, Inc.

NOTICE OF ACCEPTANCE: EVIDENCE SUBMITTED

2. Evidence submitted under previous file # 17-1102.09.
- A. **DRAWINGS**
1. Drawing No. QEP005, titled "Full Louvered Steel Doors", sheets 1 through 7 of 7, prepared by manufacturer, dated 01/31/18, signed and sealed by Cody Davis, P. E.
- B. **Test**
1. None.
- C. **CALCULATIONS**
1. None.
- D. **QUALITY ASSURANCE**
1. Miami Dade Department of Regulatory and Economic Resources (RER).
- E. **MATERIAL CERTIFICATIONS**
1. Notice of Acceptance No. 17-1207.05 issued to Dyplastic Products, LLC (former Apache Products Co) for "E& R-Board Expanded Polystyrene Rigid Foam Insulation", expiring on 01/11/2022.
- F. **STATEMENTS**
1. Statement letter of conformance to FBC 2017 (6th Edition), dated 12/01/17, prepared by Master Consulting Engineer Inc., signed and sealed by Cody Davis, P. E.
- G. **OTHER**
1. This NOA revises # 15-0422.10, expiring 12/30/19.
3. Evidence submitted under previous submittal.
- A. **DRAWINGS**
1. Drawing No. QEP005, titled "Full Louvered Steel Doors", sheets 1 through 7 of 7, prepared by manufacturer, dated 01/31/18, signed and sealed by Cody Davis, P. E. (submitted under file# 17-1102.09).
- B. **Test**
1. None.
- C. **CALCULATIONS**
1. None.
- D. **QUALITY ASSURANCE**
1. Miami Dade Department of Regulatory and Economic Resources (RER).
- E. **MATERIAL CERTIFICATIONS**
1. Notice of Acceptance No. 17-1207.05 issued to Dyplastic Products, LLC (former Apache Products Co) for "E& R-Board Expanded Polystyrene Rigid Foam Insulation", expiring on 01/11/2022.
- F. **STATEMENTS**
1. Statement letter of conformance to FBC 2017 (6th Edition), dated 12/01/17, prepared by Master Consulting Engineer Inc., signed and sealed by Cody Davis, P. E. (submitted under file# 17-1102.09).
- G. **OTHER**
1. This NOA revises # # 17-1102.09, expiring 12/30/19. *Ishaq I. Chanda*

Ishaq I. Chanda, P.E.
Product Control Unit Supervisor
NOA No. 20-1123.20
Expiration Date: October 28, 2024
Approval Date: April 01, 2021

NOTICE OF ACCEPTANCE: EVIDENCE SUBMITTED

4. **New Evidence submitted.**

A. **DRAWINGS**

1. Drawing No. **QEP005 Rev #2**, titled "Full Louvered Steel Doors", sheets 1 through 7 of 7, prepared by manufacturer, dated 01/31/18 and last revised on 03/03/21, signed and sealed by Cody Davis, P. E.

B. **Test**

1. None.

C. **CALCULATIONS**

1. None.

D. **QUALITY ASSURANCE**

1. Miami Dade Department of Regulatory and Economic Resources (RER).

E. **MATERIAL CERTIFICATIONS**

1. Notice of Acceptance No. **17-1207.05** issued to Dyplastic Products, LLC (former Apache Products Co) for "E& R-Board Expanded Polystyrene Rigid Foam Insulation", expiring on 01/11/2022.

F. **STATEMENTS**

1. Statement letter of conformance to FBC 2020 (7th Edition), dated March 03, 2021, prepared by Master Consulting Engineer Inc., signed and sealed by Cody Davis, P. E.

G. **OTHER**

1. This NOA revises **#19-0731.04**, expiring 10/28/24.

Ishaq I. Chanda

Ishaq I. Chanda, P.E.
Product Control Unit Supervisor
NOA No. 20-1123.20
Expiration Date: October 28, 2024
Approval Date: April 01, 2021

QUALITY ENGINEERED PRODUCTS

FULL LOUVERED COMMERCIAL STEEL DOOR (OUTSWING)

INSTALLATION NOTES:

- ONE (1) INSTALLATION ANCHOR IS REQUIRED AT EACH ANCHOR LOCATION SHOWN.
- THE NUMBER OF INSTALLATION ANCHORS DEPICTED IS THE MINIMUM NUMBER OF ANCHORS TO BE USED FOR PRODUCT INSTALLATION.
- INSTALL INDIVIDUAL INSTALLATION ANCHORS WITHIN A TOLERANCE OF 1/2 INCH OF THE DEPICTED LOCATION IN THE ANCHOR LAYOUT DETAIL (I.E. WITHOUT CONSIDERATION OF TOLERANCES). TOLERANCES ARE NOT CUMULATIVE FROM ONE INSTALLATION ANCHOR TO THE NEXT.
- SHIM AS REQUIRED AT EACH INSTALLATION ANCHOR WITH LOAD BEARING SHIMS. MAXIMUM ALLOWABLE SHIM STACK TO BE 1/4 INCH. SHIM WHERE SPACE OF 1/16 INCH OR GREATER OCCURS. SHIM(S) SHALL BE CONSTRUCTED OF HIGH DENSITY PLASTIC OR BETTER (ALUMINUM OR SS).
- FOR JAMB INSTALLATION INTO WOOD FRAMING USE 3/8" INCH DIAMETER WOOD LAG SCREWS OF SUFFICIENT LENGTH TO ACHIEVE 2 1/2 INCH MINIMUM EMBEDMENT INTO WOOD SUBSTRATE. WOOD LAG SCREWS TO BE USED IN 3/4 INCH EMIT PIPE SLEEVE.
- FOR JAMB INSTALLATION THROUGH 1X BUCK TO CONCRETE/MASONRY, OR DIRECTLY INTO CONCRETE/MASONRY, USE 3/8" INCH DIAMETER DYNABOLT SLEEVE ANCHOR BY ITW/REDHEAD OF SUFFICIENT LENGTH TO ACHIEVE 2 3/8 INCH MINIMUM EMBEDMENT.
- FOR INSTALLATION INTO STRUCTURAL STEEL, USE 3/8"Ø SCREW THRU EMIT PIPE SLEEVE CONFORMING TO SAE GRADE 2 OR EQUAL. MINIMUM MATERIAL THICKNESS = 3/8" THICK CONFORMING TO A36 STEEL.
- MINIMUM EMBEDMENT AND EDGE DISTANCE EXCLUDE WALL FINISHES, INCLUDING BUT NOT LIMITED TO STUCCO, FOAM, BRICK VENEER, AND SIDING.
- INSTALLATION ANCHORS AND ASSOCIATED HARDWARE MUST BE MADE OF CORROSION RESISTANT MATERIAL OR HAVE A CORROSION RESISTANT COATING.
- FOR HOLLOW BLOCK AND GROUT FILLED BLOCK, DO NOT INSTALL INSTALLATION ANCHORS INTO JOINT OR CRACKS. EDGE DISTANCE IS MEASURED FROM FREE EDGE OF BLOCK OR EDGE OF MORTAR JOINT INTO FACE SHELL OF BLOCK.
- INSTALLATION ANCHORS SHALL BE INSTALLED IN ACCORDANCE WITH ANCHOR MANUFACTURER'S INSTALLATION INSTRUCTIONS AND ANCHORS SHALL NOT BE USED IN SUBSTRATES WITH STRENGTHS LESS THAN THE MINIMUM STRENGTH SPECIFIED BY THE ANCHOR MANUFACTURER.
- INSTALLATION ANCHOR CAPACITIES FOR PRODUCTS HEREIN ARE BASED ON SUBSTRATE MATERIALS WITH THE FOLLOWING PROPERTIES:
 - WOOD - MINIMUM SPECIFIC GRAVITY OF 0.65.
 - CONCRETE - MINIMUM COMPRESSIVE STRENGTH OF 3000 PSI.
 - GROUTED MASONRY - STRENGTH CONFORMANCE TO ASTM C-90, NORMAL WEIGHT w/ 2 KSI STRENGTH. GROUT SHALL BE MIN. 3000 PSI.
 - STRUCTURAL STEEL - MEMBER TO COMPLY WITH AISC 360. ADEQUACY OF METAL STRUCTURE TO BE REVIEWED BY BUILDING OFFICIAL.

GENERAL NOTES:

- THE PRODUCT SHOWN HEREIN IS DESIGNED AND MANUFACTURED TO COMPLY WITH THE FLORIDA BUILDING CODE 7TH EDITION (2020), INCLUDING HVHZ AND HAS BEEN EVALUATED ACCORDING TO THE FOLLOWING: TAS 201-94/TAS 202-94 (STRUCTURAL ONLY)/TAS 203-94.
- ADEQUACY OF THE EXISTING STRUCTURAL CONCRETE, MASONRY, STRUCTURAL STEEL AND 2X FRAMING AS A HVHZ-ZONE CAPABLE OF WITHSTANDING AND TRANSFERRING APPLIED PRODUCT LOADS TO THE FOUNDATION IS THE RESPONSIBILITY OF THE ENGINEER OR ARCHITECT OF RECORD FOR THE PROJECT OF INSTALLATION.
- 1X AND 2X BUCKS (WHEN USED) SHALL BE DESIGNED AND ANCHORED TO PROPERLY TRANSFER ALL LOADS TO THE STRUCTURE. BUCK DESIGN AND INSTALLATION IS THE RESPONSIBILITY OF THE ENGINEER OR ARCHITECT OF RECORD FOR THE PROJECT OF INSTALLATION.
- RECORD FOR THE INSTALLATION DETAILS DESCRIBED HEREIN ARE GENERIC AND MAY NOT REFLECT ACTUAL CONDITIONS FOR A SPECIFIC SITE. IF SITE CONDITIONS CAUSE INSTALLATION TO DEVIATE FROM THE REQUIREMENTS DETAILED HEREIN, A LICENSED ENGINEER OR ARCHITECT SHALL PREPARE SITE SPECIFIC DOCUMENTS FOR USE WITH THIS DOCUMENT.
- THIS PRODUCT IS LARGE AND SMALL MISSILE IMPACT RESISTANT. APPROVED IMPACT PROTECTIVE SYSTEM IS NOT REQUIRED ON THIS PRODUCT IN AREAS REQUIRING IMPACT RESISTANCE.
- DOOR AND DOOR FRAME MATERIAL: 16 GA. OR 14 GA. STEEL MEETING FVMN-46.3 KSI; FVMN-52.1 KSI OR STAINLESS STEEL FVMN-50.5 KSI; FVMN-98.5 KSI. MIL-CERTIFICATE REQUIRED FOR VERIFICATION OF AVAILABLE STRENGTH.
- DESIGNATIONS "X" AND "O" STAND FOR THE FOLLOWING:
 - APPROXIMATE PANEL
 - FIXED PANEL

| TABLE OF CONTENTS | |
|-------------------|---|
| SHEET | REVISION |
| 1 | INSTALLATION & GENERAL NOTES |
| 2 | ELEVATIONS & DETAILS |
| 3 | ANCHOR LAYOUTS |
| 4 | VERTICAL SECTIONS & DETAILS |
| 5 | VERTICAL SECTIONS & DETAILS |
| 6 | HORIZONTAL SECTION, BILL OF MATERIALS & DETAILS |
| 7 | DETAILS |

| DESIGN PRESSURE RATINGS (OUTSWING DOORS WITH LOUVERS) | | |
|--|--|--|
| WHERE AIR AND WATER FILTRATION REQUIREMENT IS NOT NEEDED | WHERE AIR AND WATER FILTRATION REQUIREMENT IS NEEDED | MISSILE IMPACT RATING |
| POSITIVE | +70.0 PSF | NOT APPROVED LARGE AND SMALL IMPACT RATED |
| NEGATIVE | -70.0 PSF | NOT APPROVED LARGE AND SMALL IMPACT RATED |

Quality Engineered Products Co., Inc.
4506 QUALITY LN
TAMPA, FL 33634
PH: (813) 985-1692 FX: (813) 984-2073

4506 QUALITY LN
TAMPA, FL 33634
Quality Engineering Products, Inc.
4506 Quality Lane
PH: (813) 885-1693 FX: (813) 644-2266

REVISIONS

| DATE | DESCRIPTION | BY |
|----------|-------------|----|
| 02.26.16 | 2014 FBC | CD |
| 02.10.21 | 2020 FBC | TA |

PREPARED BY: Quality Engineering Products, Inc.
GENERAL NOTES: FULL LOUVERED STEEL DOOR

DATE: 02.26.16
DWG #: QEP005
SHEET: 1 OF 7

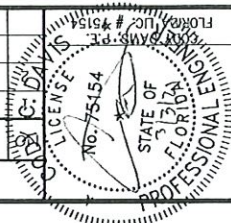

Quality
Engineered
Products Co., Inc.

4506 QUALITY LN.
TAMPA, FL 33634
PH: (813) 885-1693 FX: (813) 884-3273

PREPARED BY:
Quality Engineering Products,
INC.
4506 Quality Lane,
Tampa, FL 33684
PH: (813) 885-1693 FX: (813) 644-2366

| BY | DATE | DESCRIPTION |
|----|----------|-------------|
| CD | 02.26.16 | 2014 FBC |
| TA | 02.10.21 | 2020 FBC |

REVISIONS

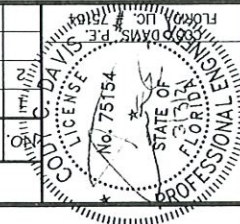

| | |
|---------|----------|
| DATE: | 02.26.16 |
| DWN BY: | JLR |
| CHK BY: | CCD |
| SCALE: | NTS |

DWG #: **QEPO05**
SHEET: **2 OF 7**

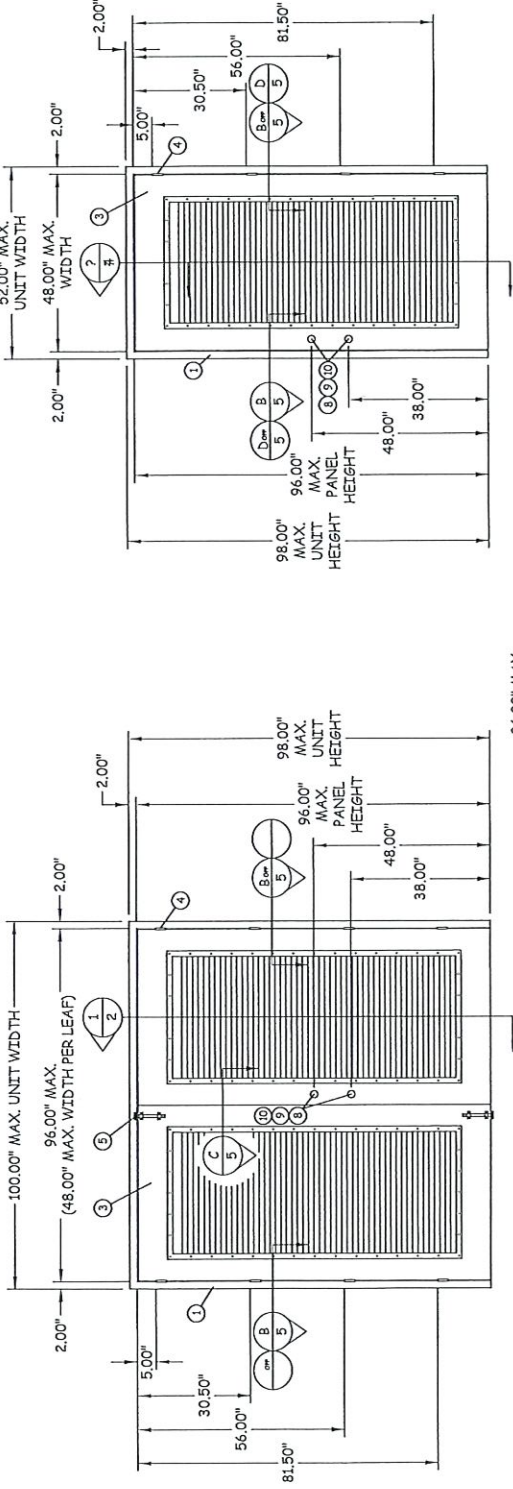

ELEVATION

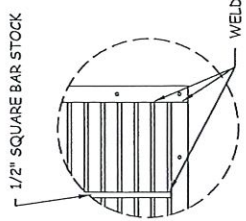

DETAIL A

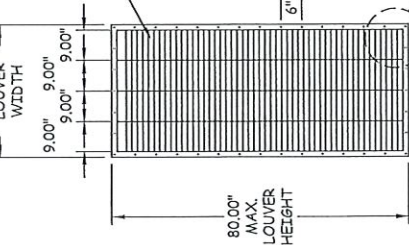

INTERIOR VIEW
LOUVER

ELEVATION

PRODUCT REVISED
as complying with the Florida
Building Code
NOA-No. **20-1123-20**
Expiration Date **10/28/2024**
By **15Aug 1, L. French**
Miami-Dade Product Control

- (3) PIECES, EACH LOUVER, 1/2" SQUARE BAR STOCK FROM TAMPA STEEL & SUPPLY WELDED TO LOUVER FRAME AND TACK WELDED TO EACH LOUVER BLADE
- EACH LOUVER ATTACHED TO THE DOOR WITH (38) #6 X 1/2" SQUARE DRIVE SCREWS
- 14 - (LEFT)
- 14 - (RIGHT)
- 5 - (TOP)
- 5 - (BOTTOM)

SEE DETAIL A

Quality
Engineered
Products Co., Inc.

4506 QUALITY LN.
TAMPA, FL 33634
PH: (813) 885-6093 FX: (813) 884-2073

PREPARED BY:
Quality Engineering Products,
Tampa, FL, FL 33684
4506 Quality Lane

DATE: 02.26.16
DESCRIPTION: FULL LOWERED STEEL DOOR ANCHOR LAYOUTS

| BY | DATE | DESCRIPTION |
|----|----------|-------------|
| CD | 02.26.16 | 2014 FBC |
| TA | 02.10.21 | 2020 FBC |

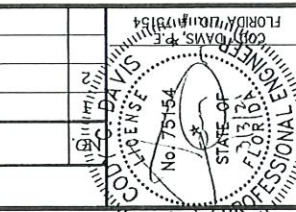

DATE: 02.26.16
DWN BY: JLR
CHK BY: CD
SCALE: NTS

DWG #:
QEPO05

SHEET: 3 OF 7

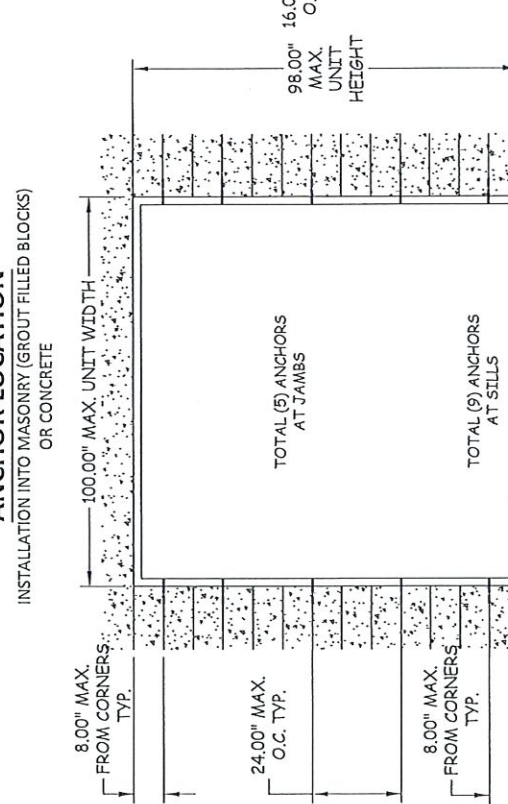
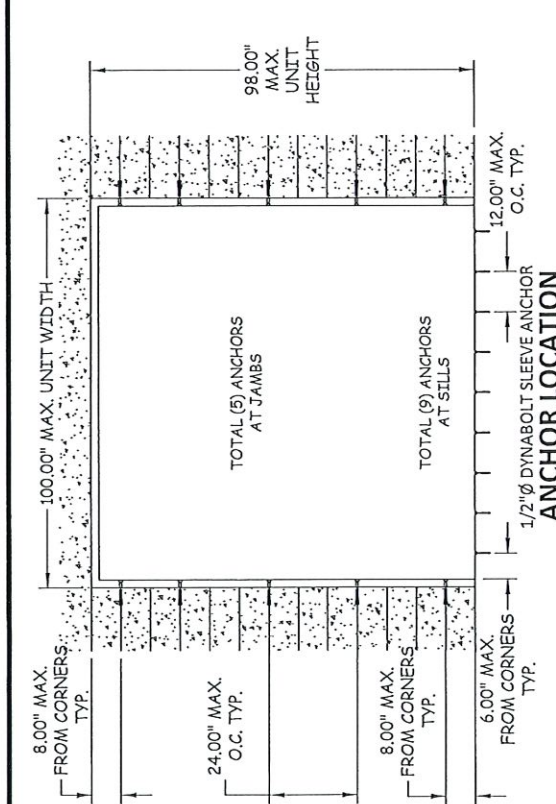
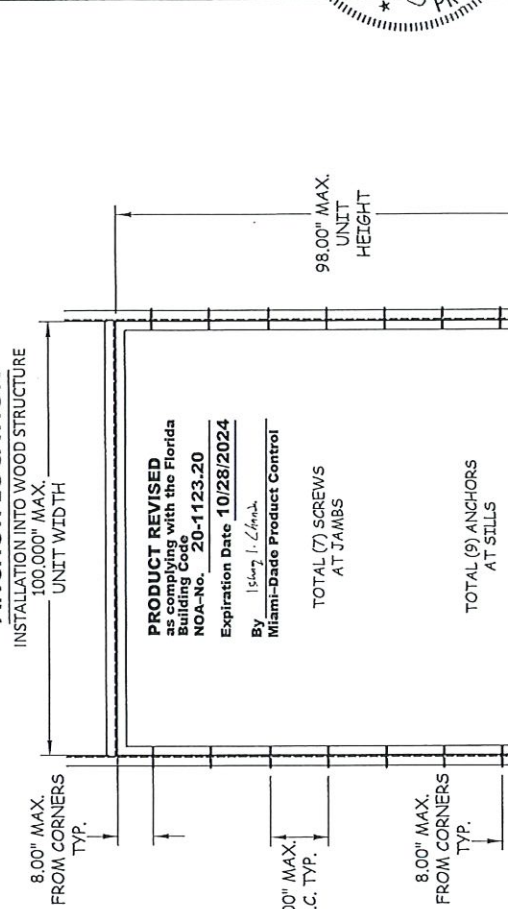
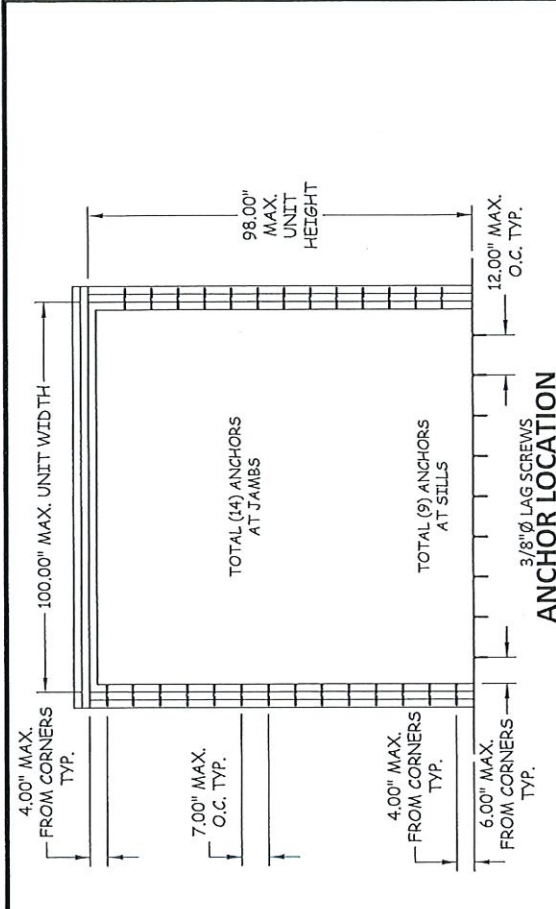

PRODUCT REVISED
as complying with the Florida Building Code
NOA-No. 20-1123.20
Expiration Date 10/28/2024
BY: Istiny I. Zhanh
Miami-Dade Product Control

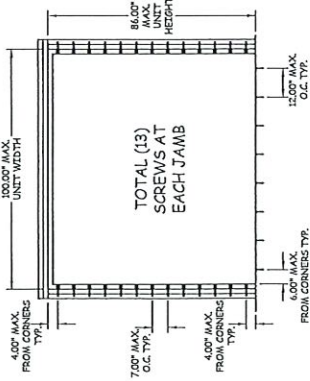

3/8" DIA. LAG SCREWS
ANCHOR LOCATION
 INSTALLATION INTO WOOD STRUCTURE

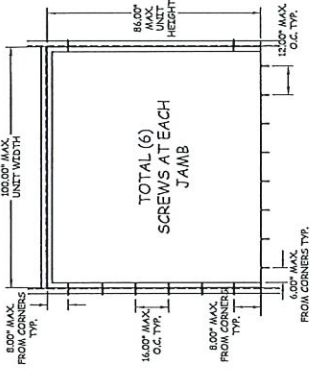

3/8" DIA THRU EMT PIPE SLEEVE
SELF-DRILLING SCREWS
ANCHOR LOCATION
 INSTALLATION INTO STRUCTURAL STEEL

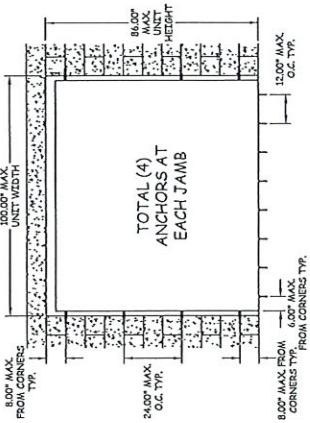

DYNABOLT SLEEVE ANCHOR
ANCHOR LOCATION
 INSTALLATION INTO EXIST. MASONRY (GROUT FILLED BLOCKS)
 OR CONCRETE

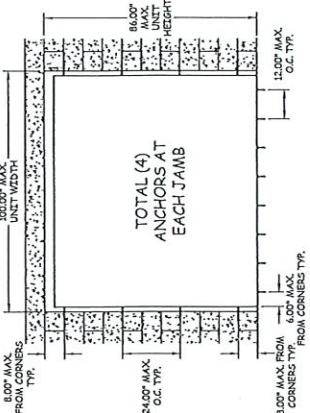

3/8" DIA WIRE ANCHOR & 16 GA. T-ANCHOR OR 1/2" DIA
ANCHOR LOCATION
 INSTALLATION INTO EXIST. MASONRY
 (GROUT FILLED BLOCKS)

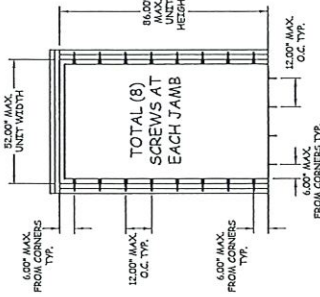

3/8" DIA. LAG SCREWS
ANCHOR LOCATION
 INSTALLATION INTO WOOD STRUCTURE

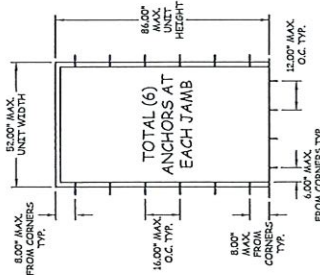

3/8" DIA THRU EMT PIPE SLEEVE
SELF-DRILLING SCREWS
ANCHOR LOCATION
 INSTALLATION INTO STRUCTURAL STEEL

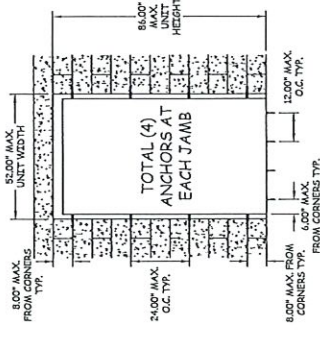

DYNABOLT SLEEVE ANCHOR
ANCHOR LOCATION
 INSTALLATION INTO EXIST. MASONRY (GROUT FILLED BLOCKS)
 OR CONCRETE

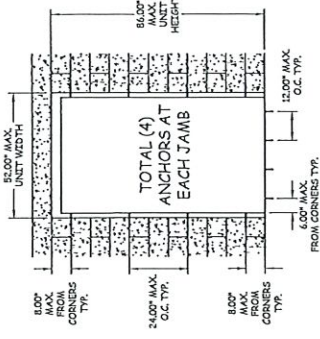

3/8" DIA WIRE ANCHOR & 16 GA. T-ANCHOR OR 1/2" DIA
ANCHOR LOCATION
 INSTALLATION INTO EXIST. MASONRY
 (GROUT FILLED BLOCKS)

REVISIONS

| NO. | DATE | DESCRIPTION | BY |
|-----|----------|-------------|----|
| 1 | 02.10.21 | 2020 FBC | TA |
| 2 | 02.26.16 | 2014 FBC | CD |

TITLE: FULL COVERED STEEL DOOR VERTICAL SECTIONS & DETAILS
 PREPARED BY: Quality Engineering Products, Inc.
 4506 Quality Lane
 Tampa, FL 33684
 PH: (813) 885-1693 FX: (813) 884-2673
 F4: (813) 885-1693 FX: (813) 644-2366

Quality Engineering Products Co., Inc.
 4506 QUALITY LN.
 TAMPA, FL 33684
 PH: (813) 885-1693 FX: (813) 884-2673



DATE: 02.26.16
 DWN BY: JLR
 CHK BY: CD
 SCALE: NTS
 DWG #: QEP005
 SHEET: 4 OF 7

PRODUCT REVISED
 in compliance with the Florida Building Code
 NOA-No. 20-1123.20
 Expiration Date 10/28/2024
 By: [Signature]
 Miami-Dade Product Control

Quality Engineered Products Co., Inc.
 4506 QUALITY LN.
 TAMPA, FL 33624
 PH: (813) 885-6693 FX: (813) 884-2072

PREPARED BY: Quality Engineering Products, INC., Tampa, FL, 33684
 PH: (813) 885-1693 FX: (813) 644-2266

| DATE | DESCRIPTION | BY |
|----------|-------------|----|
| 02.26.16 | 2014 FBC | CD |
| 02.10.21 | 2020 FBC | TA |

REVISIONS

DATE: 02.26.16
 DWN BY: JLR
 CHK BY: CCD
 SCALE: NTS

DATE: 02.10.21
 TA

DATE: 02.26.16
 DWN BY: JLR
 CHK BY: CCD
 SCALE: NTS

DWG #: QEP005
 SHEET: 5 OF 7

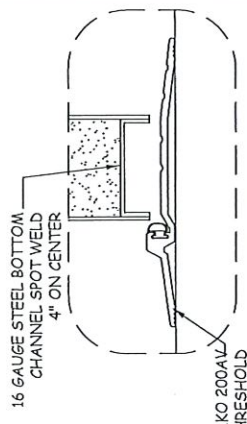

DETAIL D

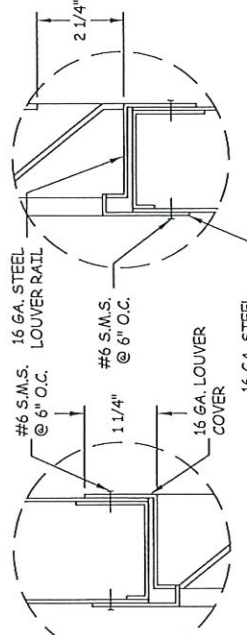

DETAIL C

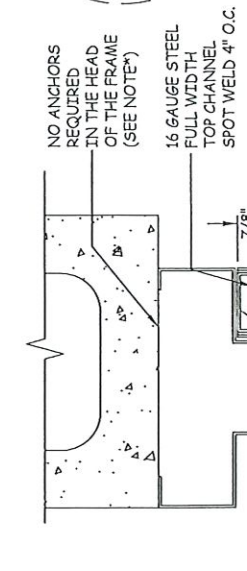

DETAIL B

PRODUCT REVISED
 as complying with the Florida Building Code
 NOA-No. 20-1123-20
 Expiration Date 10/28/2024
 By: [Signature]
 Miami-Dade Product Control

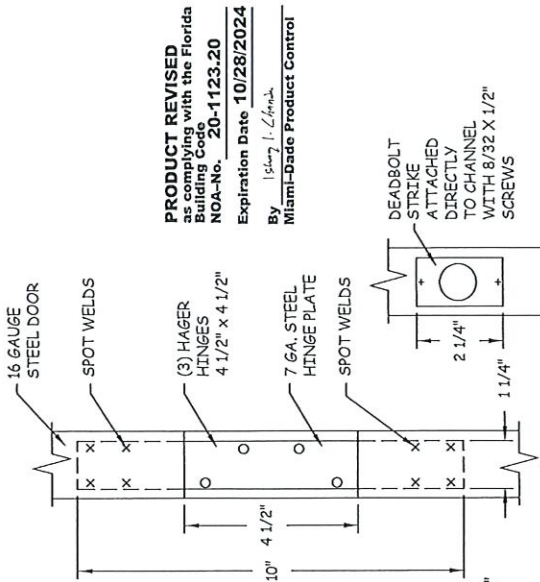

STEEL HINGE PLATE
 7 GAUGE X 1-1/4" X 10"

STEEL HINGE PLATE
 7 GAUGE X 1-1/4" X 10"

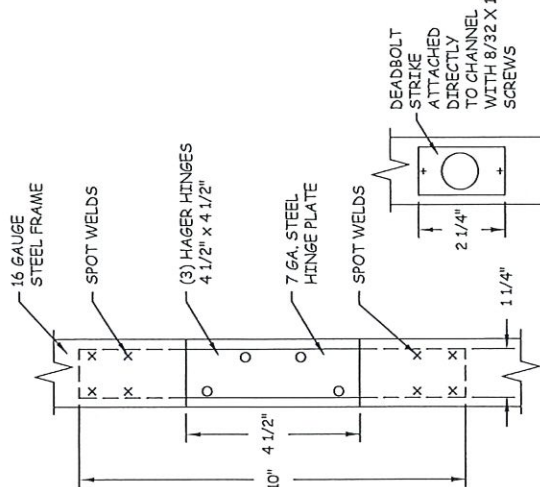

STEEL HINGE PLATE
 7 GAUGE X 1-1/4" X 10"

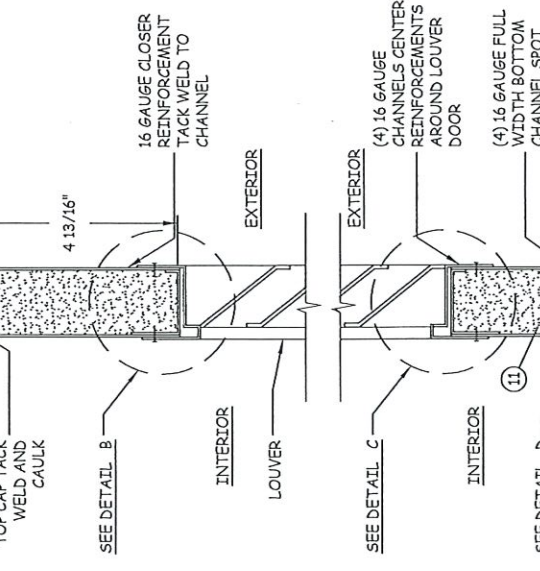

VERTICAL SECTION
 CONCRETE/MASONRY

4

*NOTE: STRUCTURAL MEMBER AT HEADER MUST DESIGN TO CARRY 179 #/FT LOAD AND MUST BE REVIEWED BY BUILDING OFFICIAL



Quality Engineered Products Co., Inc.
 4506 QUALITY LN
 TAMPA, FL 33624
 PH: (813) 885-1693 FX: (813) 884-2672

PREPARED BY: Quality Engineering Products, Inc.
 4506 Quality Lane
 Tampa, FL, 33684
 PH: (813) 885-1693 FX: (813) 644-2356

| DATE | BY | DESCRIPTION |
|----------|----|-------------|
| 02.26.16 | CD | 2014 FBC |
| 02.10.21 | CD | 2020 FBC |

REVISIONS

DATE: 02.26.16
 DWN BY: JLR
 CHK BY: CD
 SCALE: NTS
 DWG #: QEP005
 SHEET: 6 OF 7

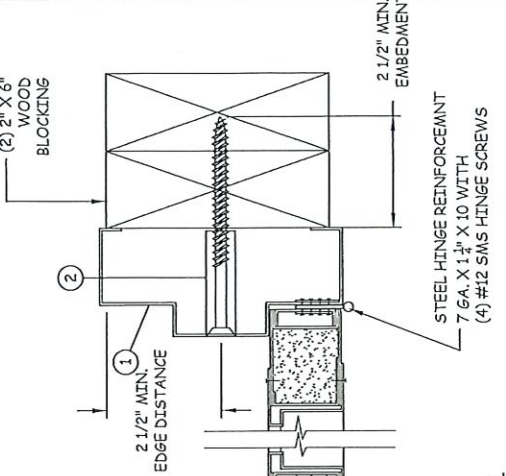

D HORIZONTAL SECTION
 JAMB - 2X WOOD FRAME

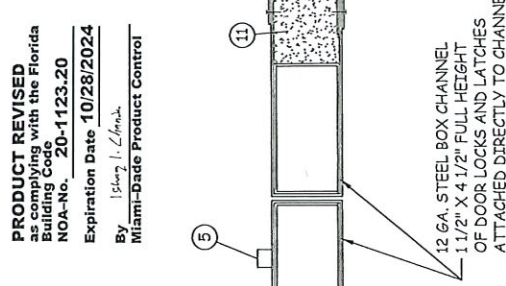

C HORIZONTAL SECTION
 ASTRAGAL

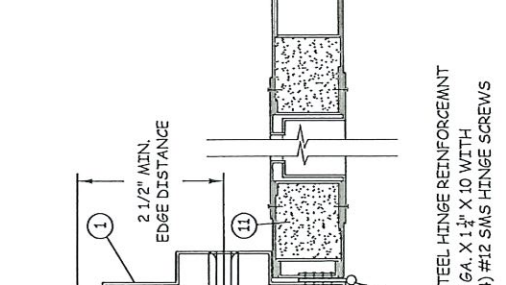

B HORIZONTAL SECTION
 JAMB - CONCRETE/MASONRY

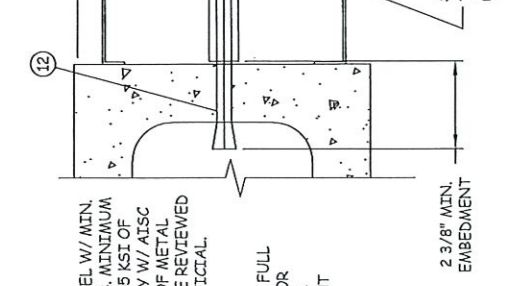

E HORIZONTAL SECTION
 JAMB - T-ANCHOR

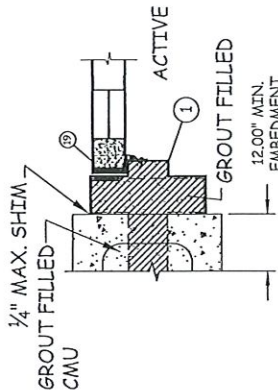

F HORIZONTAL SECTION
 JAMB - WIRE ANCHOR

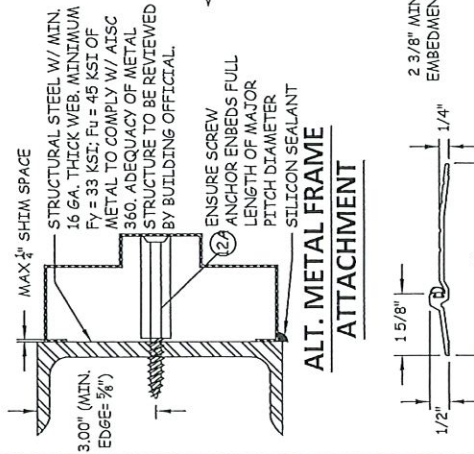
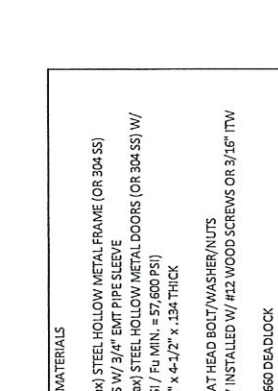

| MARK | QUANTITY | DESCRIPTION |
|------|-----------|---|
| 1 | 1 | 16 GA. (.063) MIN. (14 GA. Max) STEEL HOLLOW METAL FRAME (OR 304 SS) |
| 2 | SEE ELEV. | 3/8" X 6" WOOD LAG SCREWS W/ 3/4" EMT PIPE SLEEVE |
| 3 | 2 | 16 GA. (.063) MIN. (14 GA. Max) STEEL HOLLOW METAL DOORS (OR 304 SS) W/ LOUVERS FV MIN. = 41,200 PSI / Fu MIN. = 57,600 PSI |
| 4 | 8 | HAGER HINGES RB1279 4-1/2" x 4-1/2" x .134 THICK |
| 5 | 2 | 4VES 360 SURFACE BOLTS |
| 6 | 8 | 1/4" X 3" STAINLESS STEEL FLAT HEAD BOLT/WASHER/NUTS |
| 7 | 1 | THRESHOLD PEMKO #2005AV INSTALLED W/ #12 WOOD SCREWS OR 3/16" ITW TAPCONS (SEE ELEV.) |
| 8 | 1 | SCHLAGE ALSPD LOCK W/ B660 DEADLOCK |
| 9 | 1 | RUSWINN CLESS5 LOCK W/ DL2113 DEADLOCK |
| 10 | 1 | MARK J99AB LOCK W/ J90K DEADLOCK |
| 11 | AS REQ. | EXPANDED POLYSTYRENE (EPS) BY APPACHE PRODUCTS (CURRENT NOA) OR FIBERGLASS INSULATION |
| 12 | SEE ELEV. | 1/2" DIA. DYNABOLT/ITW/REDHEAD SLEEVE ANCHOR (3/8" DIA. BOLT X 4-1/2" SLEEVE ANCHOR W/ 3/4" DIA. WELDED PIPE SLEEVE W/ 1-7/8" MIN. EMBEDMENT & 3" MIN. EDGE DISTANCE) |
| 13 | AS REQ. | 16 GA. CUT OUT CHANNEL |
| 14 | AS REQ. | 16 GA. LOUVER RAIL |
| 15 | AS REQ. | 16 GA. LOUVER BLADE |
| 16 | AS REQ. | 16 GA. LOUVER COVER |
| 17 | SEE ELEV. | WIRE ANCHOR |
| 18 | SEE ELEV. | T-ANCHOR |

PRODUCT REVISED as complying with the Florida Building Code NOA-No. 20-1123.20
 Expiration Date 10/28/2024
 By: [Signature] I. C. [Signature]
 Miami-Dade Product Control

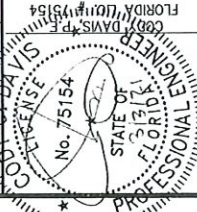

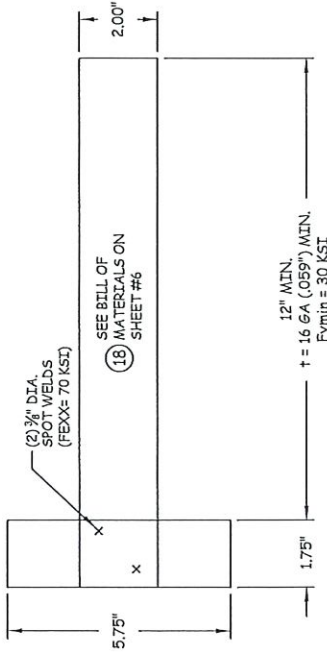

T ANCHOR ATTACHMENT

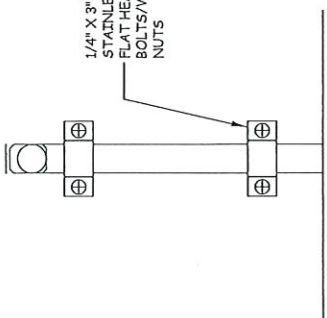

IVES 360 SURFACE BOLT

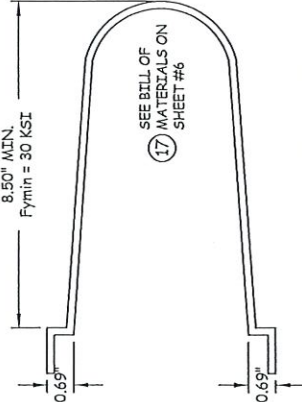

0.187" DIA. WIRE ANCHOR

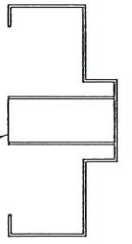
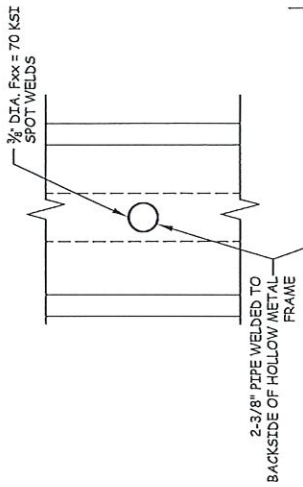

16 GA. CUT OUT CHANNEL



16 GA. LOUVER COVER

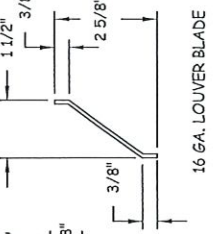

16 GA. LOUVER BLADE

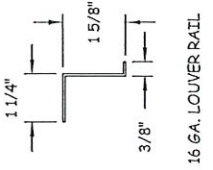

16 GA. LOUVER RAIL

PRODUCT REVISED
 in compliance with the Florida
 Building Code
 NOA-No. 20-1123-20
 Expiration Date 10/28/2024
 By *Ismael L. Lopez*
 Miami-Dade Product Control

Quality Engineered Products Co., Inc.
 4506 QUALITY LN
 TAMPA, FL 33634
 PH: (813) 885-1693 FX: (813) 884-2672
 Quality Engineering Products, Inc.
 4506 Quality Lane
 Tampa, FL, FL 33684
 PH: (813) 885-1693 FX: (813) 644-2365

TITLE:
 FULL HORIZONTAL STEEL DOOR
 HORIZONTAL SECTIONS,
 BILL OF MATERIALS & DETAILS

PREPARED BY:
 Quality Engineering Products, Inc.

REVISIONS

| NO. | DATE | DESCRIPTION | BY |
|-----|----------|-------------|-----|
| CD | 02.26.16 | 2014 FBC | JLR |
| TA | 02.10.21 | 2020 FBC | JLR |



| | |
|---------|----------|
| DATE: | 02.26.16 |
| DWN BY: | JLR |
| CHK BY: | JLR |
| CD | JLR |
| SCALE: | NTS |
| DWG #: | QE005 |
| SHEET: | 7 OF 7 |